

## COMBI 304 WH

Junction box, round Ø 82 x 57mm, Polypropylene, RAL 9001

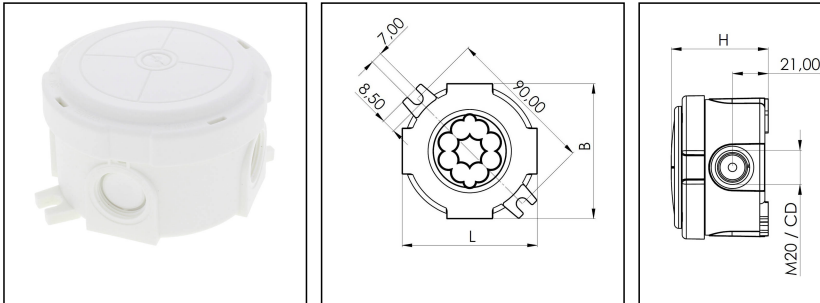

Products may differ in size, colour and appearance to those shown. If you require further information or customisation, please contact us directly.



<b>Material</b>	Polypropylene
<b>Material sealing gasket</b>	TPE
<b>Temp. range min</b>	-30 °C
<b>Temp. range max</b>	100 °C
<b>Temperatures during install.</b>	-5 °C - 60 °C
<b>Protection class</b>	IP66 / IP67
<b>Glow wire test</b>	750 °C
<b>Voltage</b>	400 V
<b>Rated cross section</b>	2,5 mm <sup>2</sup>
<b>Fixing</b>	2 external mounting feet
<b>Ø cable diameter min</b>	3 mm
<b>Ø cable diameter max</b>	12 mm
<b>External dimensions LxWxH</b>	Ø 82 x 57mm
<b>Type of cable gland</b>	M 20 x 1,5
<b>Product Color</b>	RAL 9001
<b>WISKA-Order no.</b>	10110631
<b>Type</b>	COMBI 304 WH
<b>Packing unit</b>	5
<b>ETIM-Classification</b>	EC002600
<b>EAN number</b>	4007686257786
<b>Tariff number</b>	39269097

Remarks:

IP66: using the membrane entry

IP67: using the threaded entry together with ESKV cable gland

Your Contact:

**WISKA Hoppmann GmbH**

Kisdorfer Weg 28 · 24568 Kaltenkirchen · Germany

☎ +49-4191-508-0 · 📠 +49-4191-508-209

contact@wiska.de · www.wiska.com

**Equipment:**

- 4 M20 threaded membrane entries

**Recommended accessories**

SP-KT-W 221/CSM-3x221-413	22001114
SP-KT-W 221/CSM	22001115

18.05.2022

**Your Contact:**

**WISKA Hoppmann GmbH**

Kisdorfer Weg 28 · 24568 Kaltenkirchen · Germany

☎ +49-4191-508-0 · 📠 +49-4191-508-209

contact@wiska.de · www.wiska.com

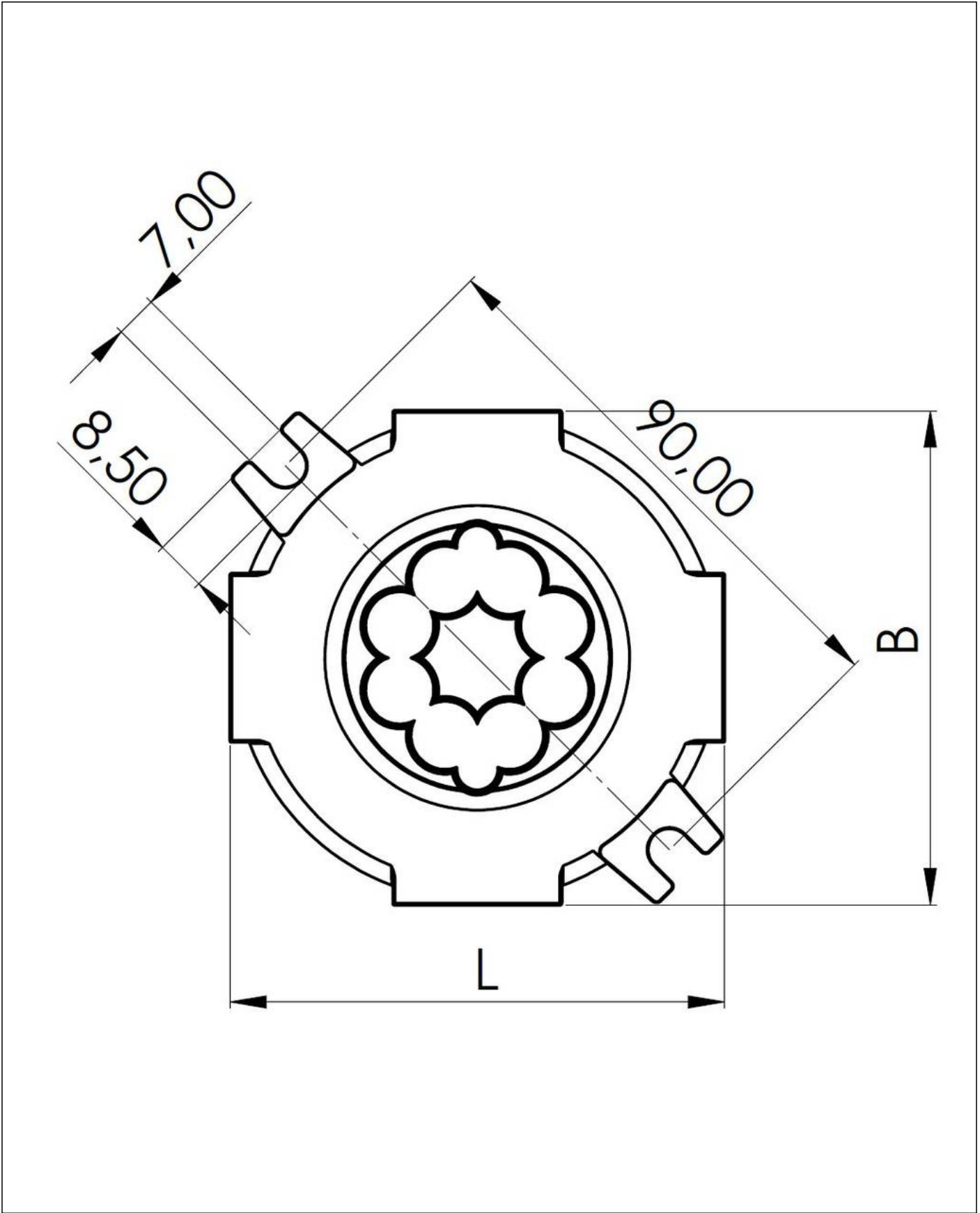

Your Contact:

**WISKA Hoppmann GmbH**

Kisdorfer Weg 28 · 24568 Kaltenkirchen · Germany

☎ +49-4191-508-0 · 📠 +49-4191-508-209

contact@wiska.de · www.wiska.com

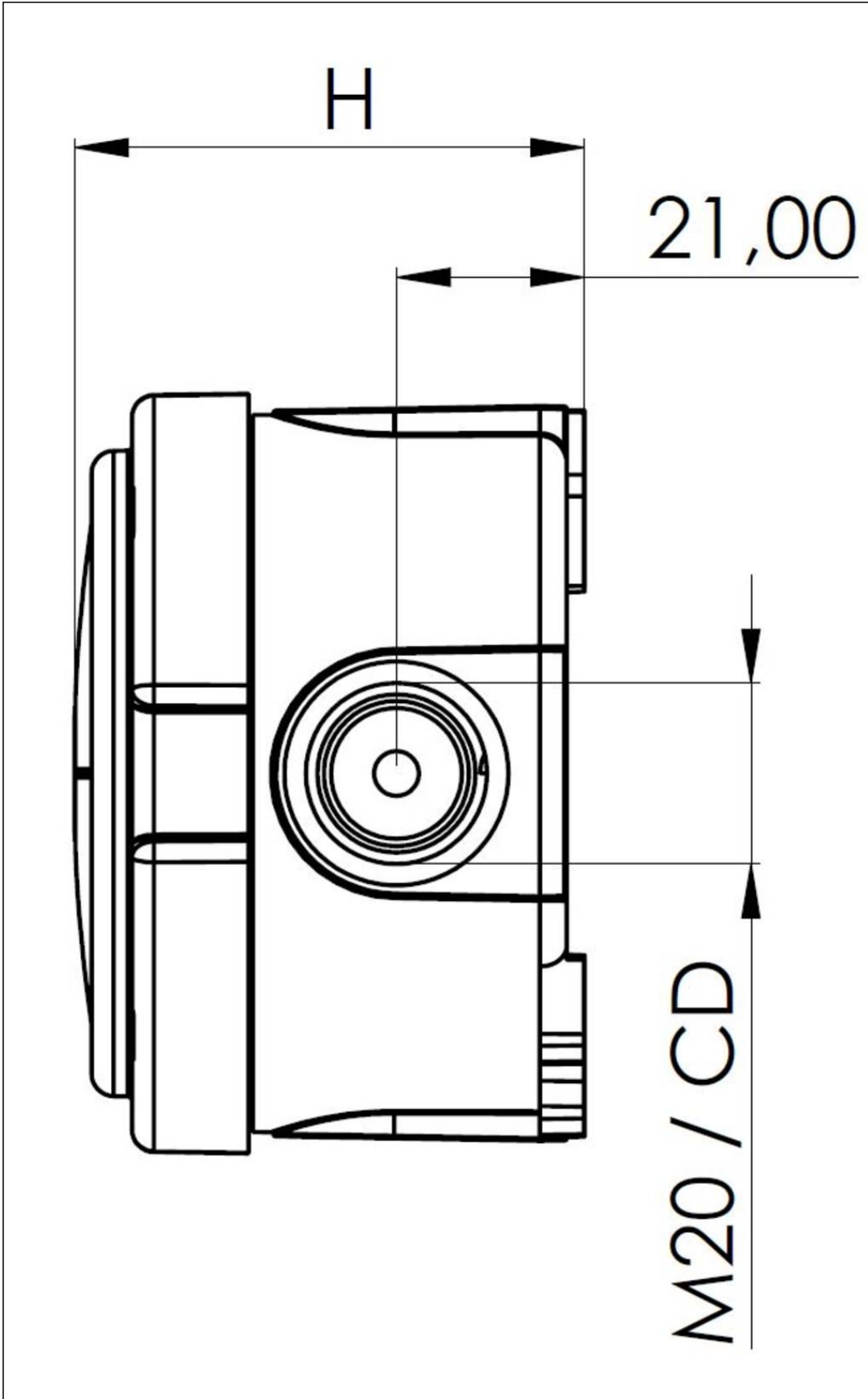

Your Contact:

**WISKA Hoppmann GmbH**

Kisdorfer Weg 28 · 24568 Kaltenkirchen · Germany

☎ +49-4191-508-0 · 📠 +49-4191-508-209

contact@wiska.de · www.wiska.com