

Troubleshooting

Before investigating individual units for faults, it is important to check the system wiring is fault-free. Earth faults on data loops may cause communication errors.

Fault Finding

Problem	Possible Cause
No response or missing	Incorrect address setting Incorrect loop wiring (polarity reversed)
Analogue value 1	Sounder failed
Analogue value 2	Beacon failed
Analogue value 3	Sounder and beacon failed
Analogue value 4	Incorrect group or individual address setting
Device fault	Incorrect group address setting
Device fails to operate	Control panel has incorrect cause and effect programming Incorrect group address setting Incorrect tone setting
Device difficult to fit to base	Insufficient lubricant on 'O' ring
Water ingress	Weatherproof mounting pad missing or damaged Incorrect cable glands Damaged base

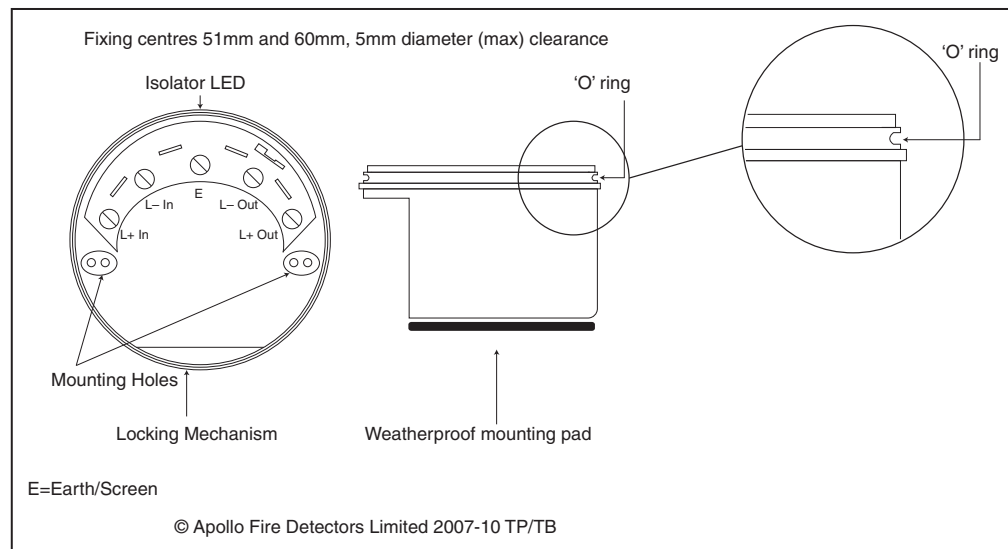

Fig 2 Base diagram



Intelligent Open-Area Sounder Beacon Installation Guide

General

This guide refers to the Intelligent Open-area Sounder Beacon, but the installation process is identical for all products listed below:

Part Number	Product Name	Type
55000-005	Intelligent Open-area Sounder Beacon Red Lens	Outdoor (Type B)
55000-006	Intelligent Open-area Sounder Beacon White Lens	Outdoor (Type B)
55000-001	Intelligent Open-area Sounder Red	Outdoor (Type B)
55000-002	Intelligent Open-area Sounder White	Outdoor (Type B)
55000-009	Intelligent Open-area Beacon Red Lens	Outdoor (Type B)
55000-010	Intelligent Open-area Beacon Clear Lens	Outdoor (Type B)

The sounder beacon is connected to control panels which use the Discovery or XP95 protocol. It complies with the requirements of EN54-3: 2001.

The sounder beacon is supplied with an isolating base. A yellow LED is illuminated if a loop short circuit is detected.

The tones incorporated in the sounder products are: Apollo Standard Tone, Slow Whoop Tone to NEN2575 and a DIN 33 404 Part 3 Tone. There are two volume settings in each sounder variant.

The flash rate of the beacon where incorporated is 1Hz.

Installation

1. Drill out the cable entries and mounting holes as required on the base (using a 20mm hole cutter for the cable entries), taking care not to damage the electronics. Do not attempt to knock these out as the base will be damaged.
2. Secure the base to the mounting surface with pan-head screws. If IP65 integrity is required, fit the weatherproof mounting pad between the base and the mounting surface. Fit the 'O' ring to the base (Fig 2) using a lubricant such as silicone grease.
3. Set the sounder address using the table overleaf.
4. To lock the sounder in the base, snip the break-out on the base rim (location shown in Fig 2.). Fit the sounder to the base.

Technical Data

Operating voltage	17–28V DC
Maximum Loop Current Consumption at 24V	
Switch-on surge	<1.2mA
Quiescent	<310µA
Operated	8mA Sounder Beacon

5mA Sounder
3.1mA Beacon

Sound output at 90° ± 3dB(A)	100dB(A)
IP Rating	65

No condensation or icing

For sound pressure levels measured to EN54–3 see document PP2203. For isolator operation information see document PP2090, both available on request.

IP rating

To maintain the integrity of the enclosure it is essential that suitable IP rated cable glands be used along with the 'O' ring provided and weatherproof mounting pad.

Individual Address Setting

The address of the Intelligent Multi-tone Sounder Beacon is set using seven segments of the eight-segment DIL switch. The eighth segment is used to adjust the volume output. Segments 1-7 of the switch are set to "0" (ON) or "1", using a small screwdriver or similar tool. A complete list of address settings is shown below.

addr	DIL switch setting 1234567	addr	DIL switch setting 1234567	addr	DIL switch setting 1234567	addr	DIL switch setting 1234567	addr	DIL switch setting 1234567
1	1000000	11	1101000	21	1010100	31	1111100	41	1001010
2	0100000	12	0011000	22	0110100	32	0000010	42	0101010
3	1100000	13	1011000	23	1110100	33	1000010	43	1101010
4	0010000	14	0111000	24	0001100	34	0100010	44	0011010
5	1010000	15	1111000	25	1001100	35	1100010	45	1011010
6	0110000	16	0000100	26	0101100	36	0010010	46	0111010
7	1110000	17	1000100	27	1101100	37	1010010	47	1111010
8	0001000	18	0100100	28	0011100	38	0110010	48	0000110
9	1001000	19	1100100	29	1011100	39	1110010	49	1000110
10	0101000	20	0010100	30	0111100	40	0001010	50	0100110
51	1100110	61	1011110	71	1110001	81	1000101	91	1101101
52	0010110	62	0111110	72	0001001	82	0100101	92	0011101
53	1010110	63	1111110	73	1001001	83	1001001	93	1011101
54	0110110	64	0000001	74	0101001	84	0010101	94	0111101
55	1110110	65	1000001	75	1101001	85	1010101	95	1111101
56	0001110	66	0100001	76	0011001	86	0110101	96	0000011
57	1001110	67	1100001	77	1011001	87	1110101	97	1000011
58	0101110	68	0010001	78	0111001	88	0001101	98	0100011
59	1101110	69	1010001	79	1111001	89	1001101	99	1100011
60	0011110	70	0110001	80	0000101	90	0101101	100	0010011
101	1010011	106	0101011	111	1111011	116	0010111	121	1001111
102	0110011	107	1101011	112	0000111	117	1010111	122	0101111
103	1110011	108	0011011	113	1000111	118	0110111	123	1101111
104	0001011	109	1011011	114	0100111	119	1110111	124	0011111
105	1001011	110	0111011	115	1100111	120	0001111	125	1011111
								126	0111111

Group Address Setting

In group mode the Intelligent Multi-tone Sounder Beacon responds to an additional address referred to as the group address, which is used to activate groups of sounders simultaneously. Individual units continue to respond to their own addresses and report their status in the normal way. A group address is set on a four-segment DIL switch which is factory set to 0000. A group address may be any spare address within—and only within—the range 112 to 126 inclusive. The required group address is set in accordance with the following table.

addr	DIL switch setting 1234	addr	DIL switch setting 1234	addr	DIL switch setting 1234
112	1111	117	0101	122	1010
113	0111	118	1001	123	0010
114	1011	119	0001	124	1100
115	0011	120	1110	125	0100
116	1101	121	0110	126	1000

Note: group mode is disabled if the group address DIL switch is set to 0000, irrespective of the protocol message.

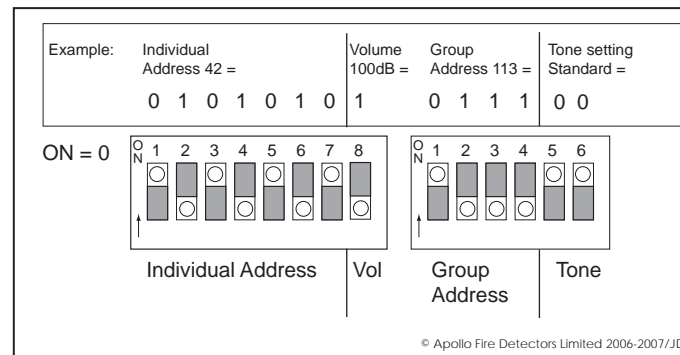

Fig 1 Example of Address and Tone Setting

Tone Setting

DIL 5	DIL 6	Tone Setting	Evacuate Tone	Alert Tone
0	0	Standard	Continuous Alternating	Pulsed
1	0	Slow Whoop	NEN2575	Continuous
0	1	DIN	DIN tone	Continuous
1	1	None	None	None

Commissioning

It is important that the Intelligent Multi-tone Sounder Beacon be fully tested after installation. An XP95 Test Set, part no. 55000-870, may be used to carry out functional testing of individual units. The test set can also perform data integrity tests of an entire system.

Functional Test Data

The sounder beacon is loop-powered and controlled by the control panel using the output bits in the communication protocol.